

999.00 EUR

incl. 19% VAT, plus shipping

CarPC JoyCon EX converts car steering wheel remote controllers into a PC USB keyboard. You can control MediaPlayer or front-ends (eg. CentraFuse) with your steering wheel audio remote controller. As the buttons of your steering wheel controller are mapped to PC keys of your choice, you will be able to control any software which can be controlled with PC keys from a keyboard.

Hardware feature

- Converts resistive steering wheel remote controls into USB HID keyboard and HID remote controller.
- Works same as standard USB HID keyboard and HID remote controller by hardware.
- 24V tolerant 4 channel resistive(voltage) input.
- Supports 28 physical buttons, 52 programmable logical buttons.
- Long and Short button for one physical button, up to 5 simultaneous key strokes by one button.
- 2 programmable LED port.
- Remote wake-up(resume PC from sleep with steering wheel remote controls).
- Channel Master/Slave selectable
- Temperature range : -40 ~ +85°C

JoyCon Explorer-aided feature

- Preset change by Preset up and down buttons.
- Speech and OSD when preset is changed, when button is pressed.
- Application link(application launches and pops up with preset changing).
- User definable Button Speech and OSD.
- Automatic Button Detection
- Rearview with USB camera
- Online firmware update.

- No external power or driver installation needs.

- Available OS : Windows 7, Vista, XP, 2003

(JoyCon Explorer supports Windows XP and the later version. JoyCon Explorer does not support Linux. But CarPC JoyCon Exr works on Linux and Mac after it is configured at Windows.)

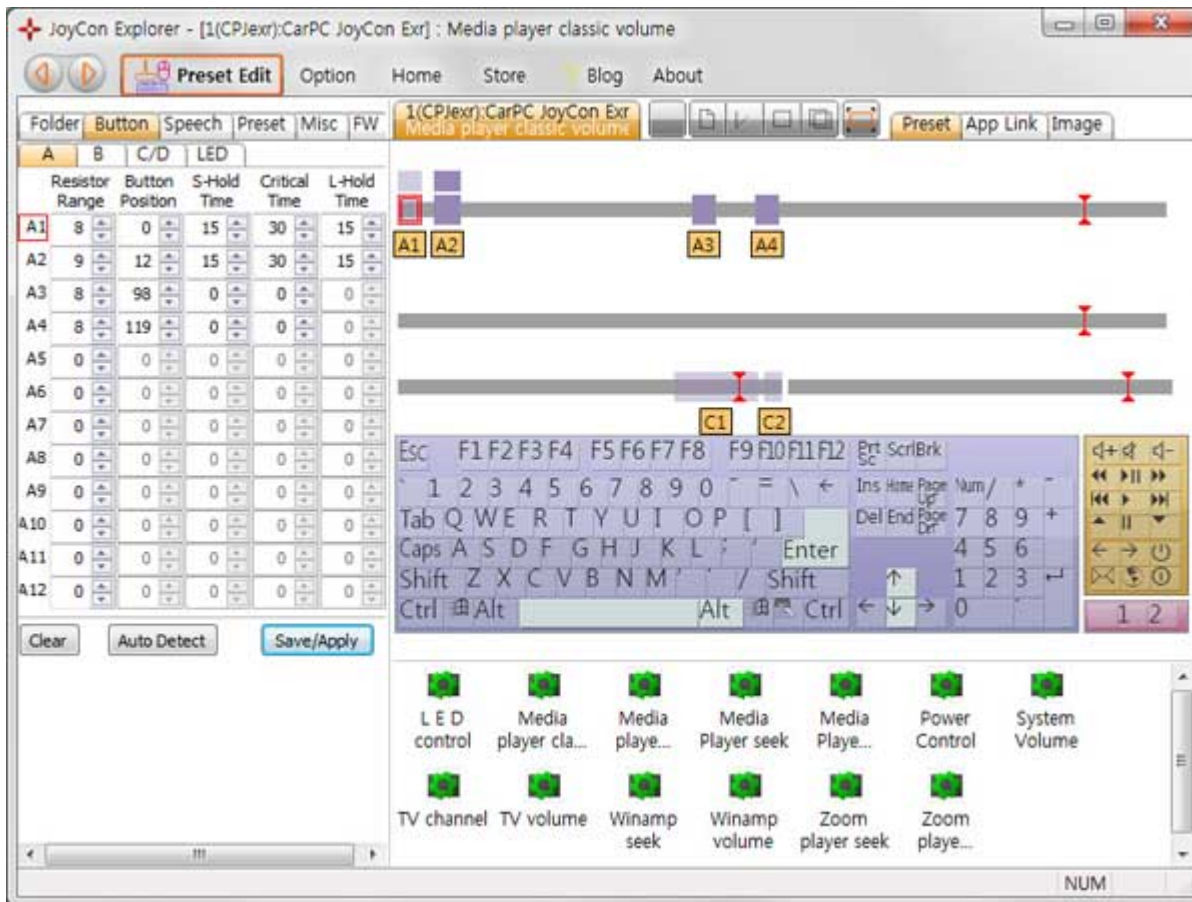

App Link enables to launch application with steering wheel remote control's button and switch application when preset is changed.

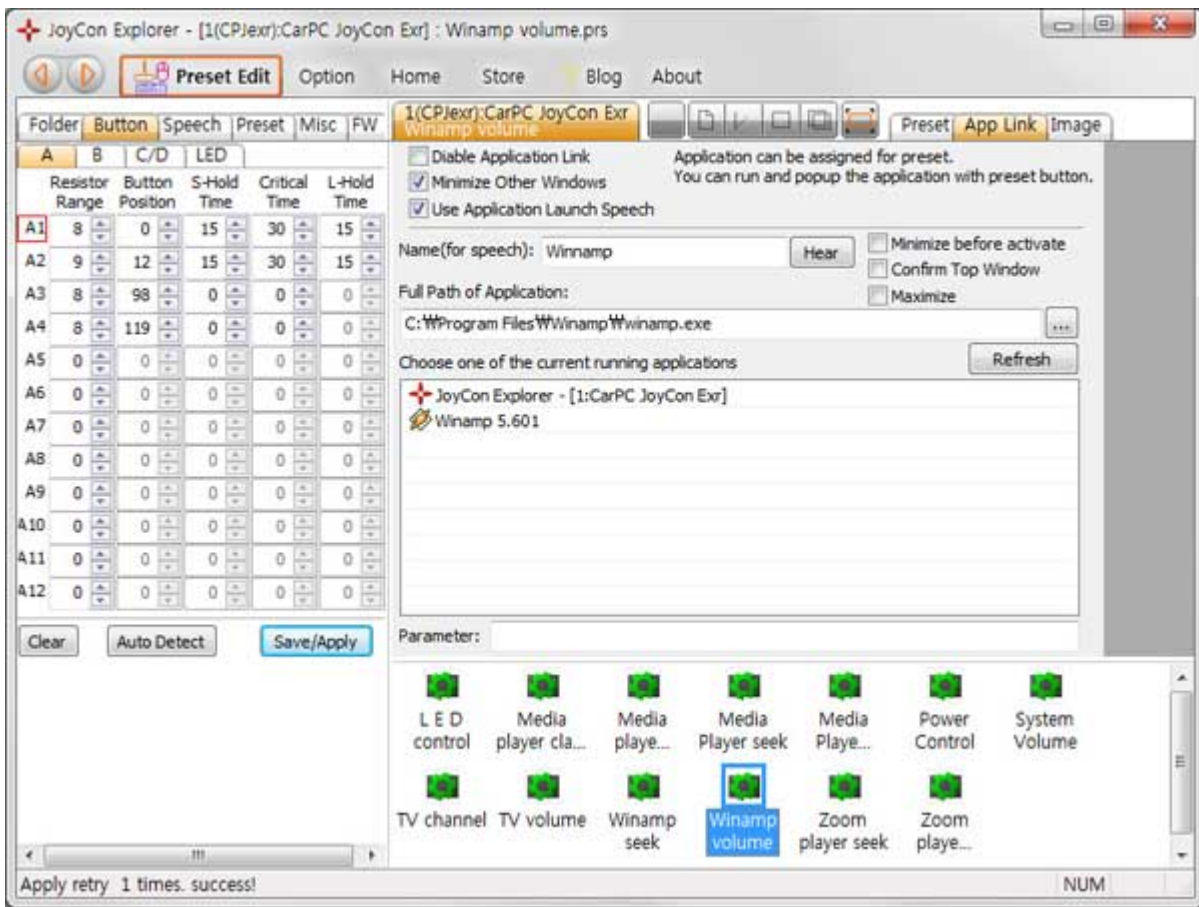

[http://www.changjack.com/software/Jex_Setup_XP\(101229\).zip](http://www.changjack.com/software/Jex_Setup_XP(101229).zip)
[http://www.changjack.com/software/Jex_Setup_Win7\(101229\).zip](http://www.changjack.com/software/Jex_Setup_Win7(101229).zip)

Connect two wires of CarPC JoyCon Exr's input channel to the remote controls, and connect USB.

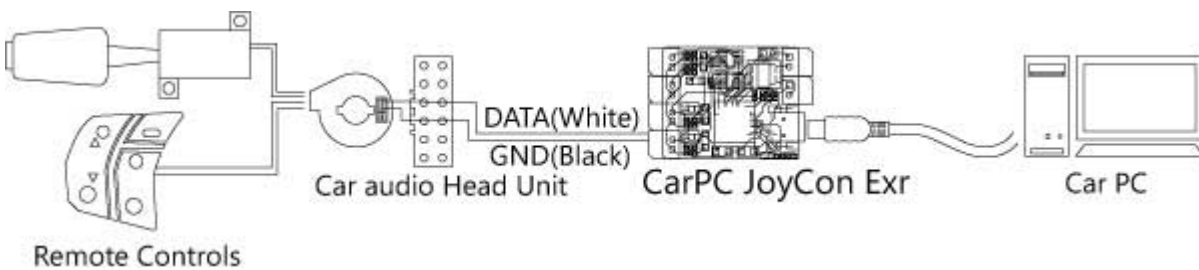

This is the typical resistance-output steering wheel remote controller's circuit. You can put additional buttons like green box below by DIY, if you want.

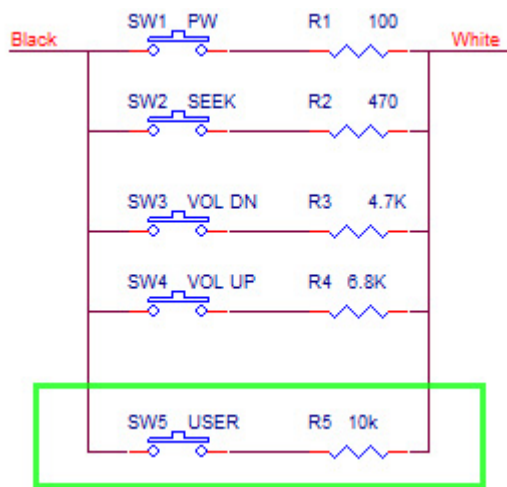

You can control two external LED.



UserGuide

http://www.changjack.com/user_guide/cpjexr/CarPC_JoyCon_Exr_UserGuide_eng.pdf

You can use typical USB cam as a rearview camera with CarPC JoyCon Exr.
Any USB camera or video capture device can be rearview camera.

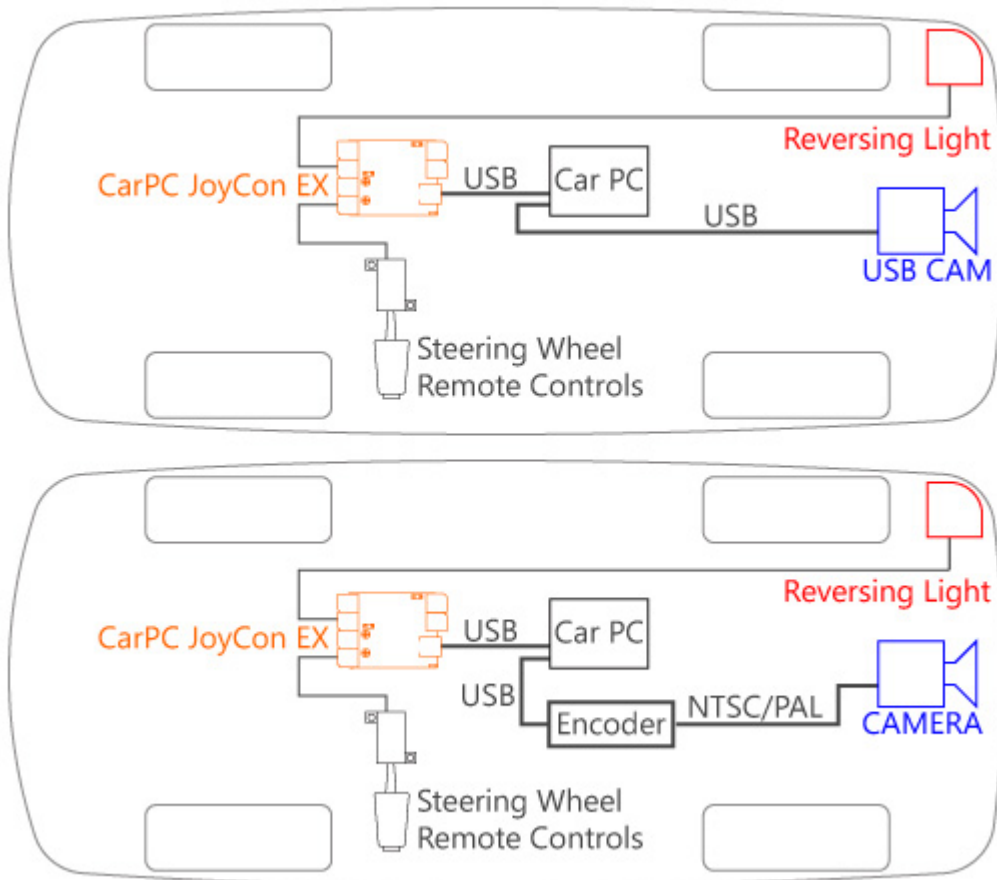

Rearview pops up when Channel C detects reversing light,

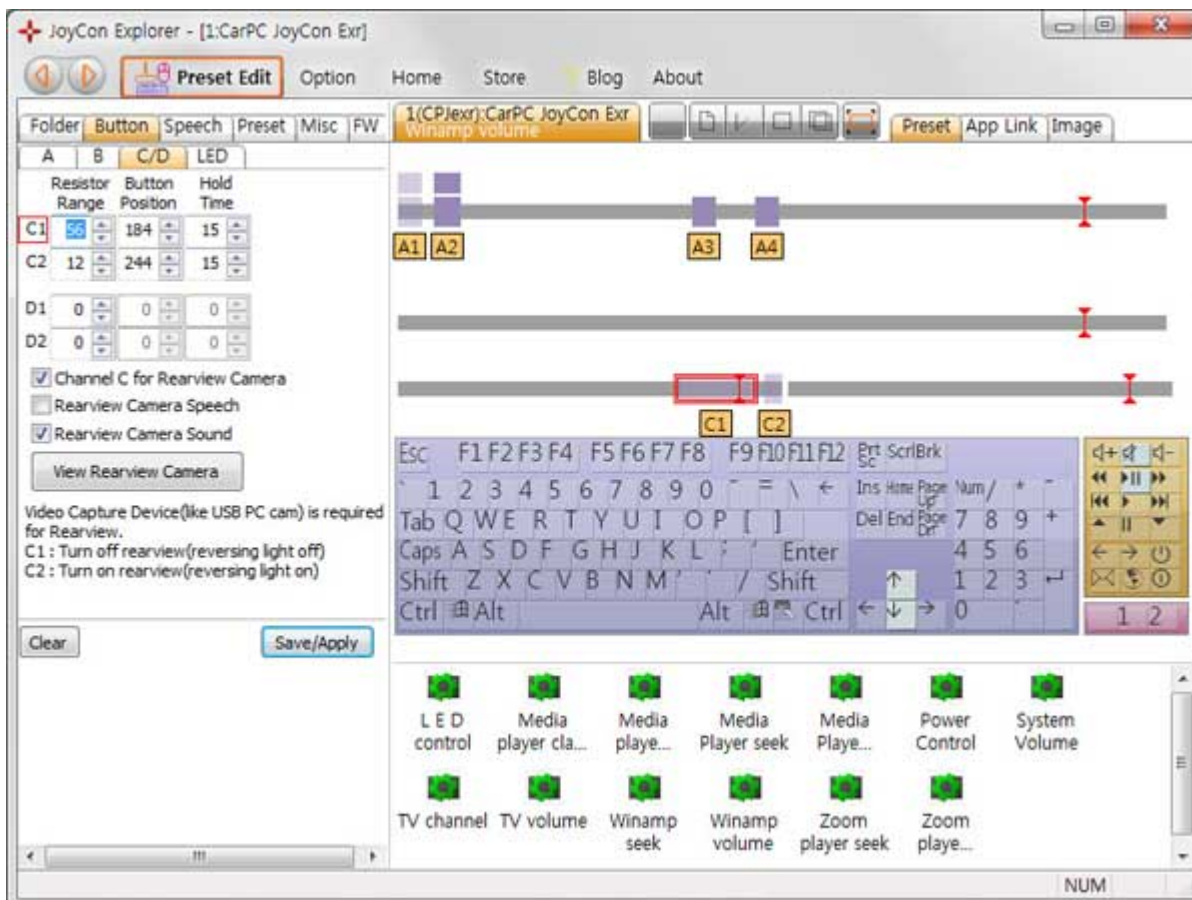

Jex Cam shows when reversing light is detected.
Any video capture device can be rearview camera.
Horizontal and Vertical Mirror is supported.

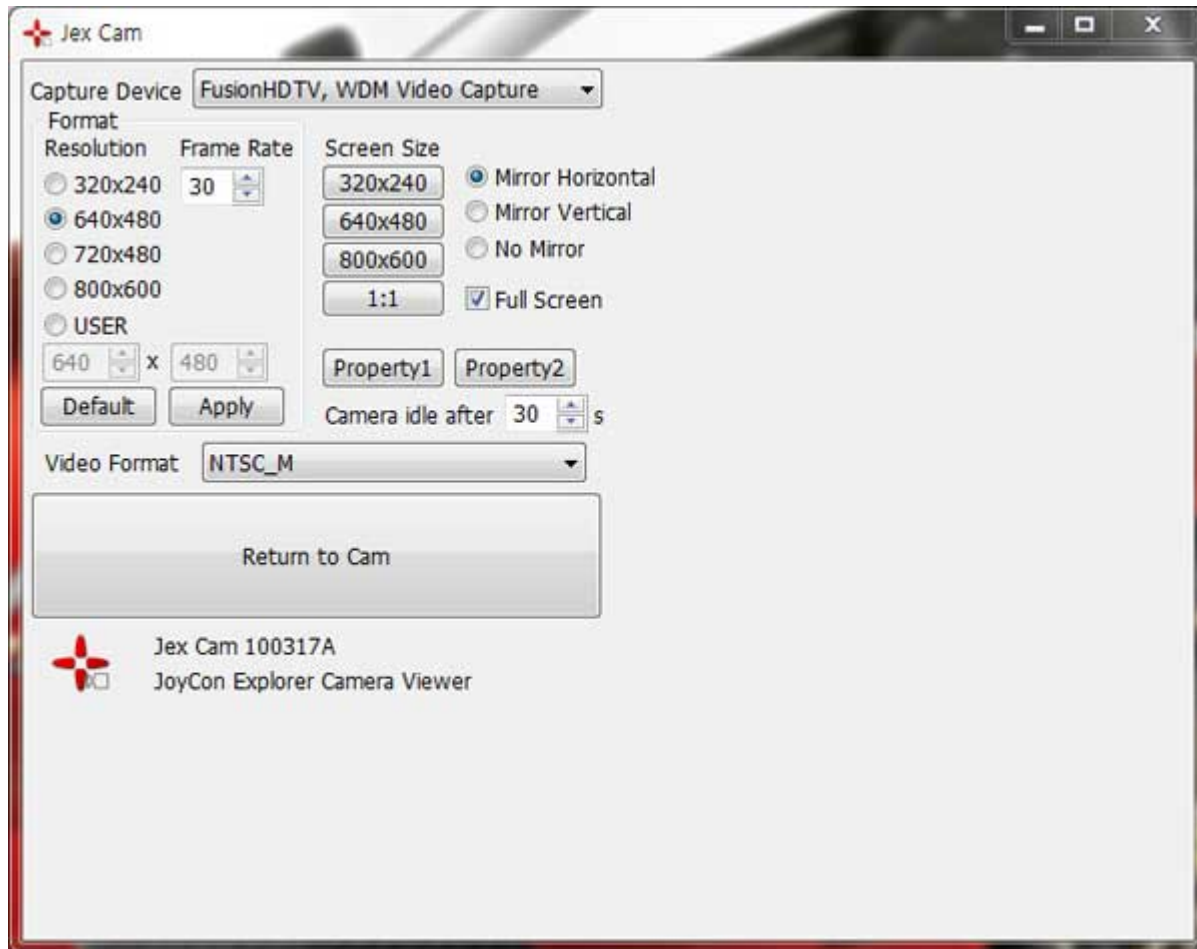

This video shows rearview test with USB camera.

[How to use Steering wheel remote controls in Centrafuse](#)

Supported cars(reported so far):

Alfa Romeo 156 2.0 JTS
Chevrolet Captiva
Chevrolet Cavalier
Citroen Xantia
Citroen XSARA 1997-2000
Dodge Durango
Fiat GrandePunto

Ford Fiesta
Ford Focus
Ford Fusion 2010
Ford Mondeo
Ford Mondeo MK2 1996-2000(Resistive PCB is required)
Ford Ranger(Cruise control only)
GM Cadillac Escalade 2002
GM Daewoo all model
Honda CRZ
Honda Ridgeline
Hyundai all model(except Sonata2/3, Marcia, Santamo)
KIA all model
Land Rover Discovery 4
Mazda3 2004-2009
Mitsubishi 380GT 2006
Nissan 350Z
Nissan Cube
Nissan Murano
Nissan Navara 2007
Peugeot 306(Resistive PCB is required)
Peugeot 806
Pontiac Firebird 96
Renault Samsung SM5/7(Audio controller only)
Rover
SAAB 9-3 9-5
Scion TC 2006
Subaru Impreza
Suzuki SX4
Toyota Camry 2005 - 2010
Toyota Corolla 2004(Cruise control only)
Toyota Corolla 2009-2010
Toyota Land Cruiser 2004
Toyota Landcruiser 200 series (2007 – 2010)
Toyota Lexus 330
Toyota supra 1990
Toyota Yaris
Vauxhall Astra G 1998-2004
Vauxhall Vectra 1999-2002
Vauxhall Vectra B 1996-2002
Vauxhall Zaffira A 1998-2005
and many other cars with resistive steering wheel controls

Supported remote controller:

Sony RM-X2S

Sony RM-X11M



What is different Exr from Ex?

Exr is almost same with Ex.

Exr can select master/slave mode by software option(at JoyCon Explorer).

Master mode is to connect CPJexr to PC only.

Slave mode is to connect CPJexr both to PC and Car Radio.

In the previous EX version, user had to desolder the diodes on the PCB manually to use slave mode.

And Exr has an extension port for future upgrade.